



## SLIDING GATE OPERATOR

### Installation SLY2500

For gates up to 2.500kg

[www.liftmaster.de](http://www.liftmaster.de)  
Email: [info@chamberlain.de](mailto:info@chamberlain.de)

- int** Int. Service (+49) 6838/907 172
- de** für Service 06838/907 172
- en** for service (+44) 0845 602 4285
- fr** pour service 03 87 95 39 28
- nl** voor service 020 684 7978

Chamberlain GmbH  
Alfred Nobel Strasse 4  
D-66793 Saarwellingen  
Germany

 **deltadoors**  
T 0341 - 42 72 00  
[www.deltadoors.nl](http://www.deltadoors.nl)

11/2008-b

## WARNING / ATTENTION

### IMPORTANT FITTING AND OPERATING INSTRUCTIONS

PLEASE START BY READING THESE IMPORTANT SAFETY RULES • SAVE THESE INSTRUCTIONS



This safety alert symbol means "Caution" - failure to comply with such an instruction involves risk of personal injury or damage to property. Please read these warnings carefully.

This gate drive mechanism is designed and tested to offer appropriately safe service provided it is installed and operated in strict accordance with the following safety rules.



*Incorrect installation and/or failure to comply with the following instructions may result in serious personal injury or property damage.*



*When using tools and small parts to install or carry out repair work on a gate exercise caution and do not wear rings, watches or loose clothing.*



Frequently examine the installation for imbalance and signs of wear or damage to cables, hardware and mountings. Do not use if repair or adjustment is necessary. Gates which stick or jam must be repaired immediately. Employ a qualified technician to repair the gate, never attempt to repair it yourself.



Installation and wiring must be in compliance with your local building and electrical installation codes. Power cables must only be connected to a properly earthed supply.



Keep additional accessories away from children. Do not allow children to play with pushbuttons or remote controls. A gate can cause serious injuries as it closes.



Any entrapment possibility by the moving wing between wing & walls must be secured with safety edges or IR-sensors.



Disconnect electric power to the system before making repairs or removing covers.



Please remove any locks fitted to the gate in order to prevent damage to the gate.

A disconnecting device must be provided in the permanently-wired installation to guarantee all-pole disconnection by means of a switch (at least 3mm contact gap) or by a separate fuse.



After the installation a final test of the full function of the system and the full function of the safety devices must be done.



Make sure that people who install, maintain or operate the gate drive and/or the control board are qualified and follow these instructions.



This drive cannot be used with a gate incorporating a wicket door unless the drive cannot be operated with the wicket door open.

Keep these instructions in a safe place so that you can refer to them quickly when you need to.



The full protection against potential squeeze or entrapment must work direct when the drive arms are installed.

### BEFORE YOU BEGIN

Make sure to leave sufficient space.

**Windload:** Even light wind may cause the motor to reverse (safety-reverse) as the forces effecting the gate are very high. This applies especially to solid panel gates.

**Gate Size:** Gate size is an important factor. Wind can slow down gate or distort it, leading to higher amount of required force.

**Gate weight:** Specification of gate weight represents only a rough parameter, which can vary according to actual demand. Operation is important.

**Influence of temperature:** Low outdoor temperatures can impede or even prevent starting torque (ground deformation etc.). High outdoor temperatures can lead to premature initiation of temperature protection switch.

**Notice:** Motors are not designed to run permanent run (continuous operation). Outside temperature and gate represent important parameters for actual operating duration.

**Attention:** This product may only be installed from professional installers. Only qualified and trained electricians may connect, programme and service the controls. Qualified and trained electricians meet the following requirements:

- have knowledge of the general and specific safety and accident prevention regulations,
- have knowledge of the relevant electrical regulations,
- are trained in the use and care of appropriate safety equipment,
- are capable of recognising the dangers associated with electricity.

Model Number:	SLY2500	SLY2500E2
Controller	none	CB400
Max. Gate weight (kg)	2500kg	2500kg
Motor Protection Switch	yes	yes
Hold to run function	no	yes
Automatic function	no	yes
IR-Sensor	no	yes
Automatic close	no	yes*
Flashing Light	no	yes*
Safety edges	no	yes*
Emergency Stop	no	yes*
Radio	no	external
External Light switching function	no	yes*
Traffic light with Red-Light	no	yes*

\* requires optional ZM-SKS-B plug in card

#### Technical Data

Voltage	230V
Phases	1
Frequency	50Hz
Capacitor	2 x 16µF
Current (nominal)	3,85A
Power	0,55 kW
Torque (max.)	120Nm
Gear Reduction	1:40
Duty Cycle Rating	50%
Temperature Range	-25/+55°C
Thermal Protection:	140°C
IP-Rating	IP55
Gate Speed	10m/min
Sprocket	90mm / Module 4
Weight	41kg

#### INSTALLATION OF DRIVE

The base for the drive can either be concreted or, if appropriate, made of steel.

The concrete plinth needs to be of an appropriate size (approx. 80cm long x 80cm wide x 100cm deep).

**Notice:** Precisely determine the height of the plinth (motor mounting socket) and the distance from the gate prior to installation. You are advised to work as precisely as possible.

#### MOUNTING MOTOR AND GEAR UNIT

The weight of the gate should not be borne by the cog wheel! Position the drive via the adjustment holes such that its location vis-à-vis the rack bar complies with the installation dimensions.

#### MOUNTING RACK BAR

The easiest way to fit the rack bar is to first place it on the motor's drive cog, disengage the motor and, by pushing the gate further with the rack bar, screwing the bar bit by bit firmly in position. In this way, you ensure that the rail bar engages with the cog wheel in an optimum manner. While doing this, do not forget to mark each fixing point.

**Notice:** Steel racks are recommended (320001 = 1m)  
For gates with weights above 3.000kg it is recommended to use two steel racks.

The tooth racks should be fitted as shown with an overlap from rack to rack. For two rack mounting the M8 screw must be replaced with a longer type to suit the application.

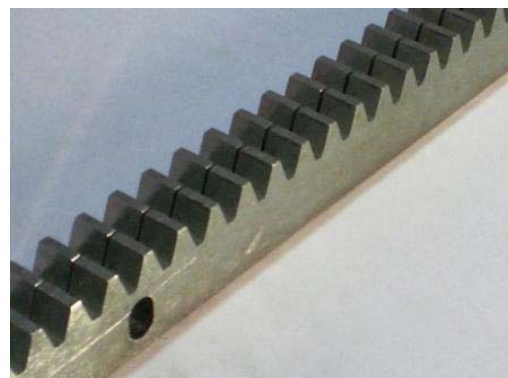

## DRIVE RELEASE MECHANISM (MANUAL OPERATION)

The drive is equipped with a lockable release mechanism to enable the gate to be operated manually during a power out.

### Open Door

1. Open lock with key
2. Push on lock to open
3. Turn opening lever into position

### Disengage gear:

Turn knob fully inside (clockwise).

### Engage gear:

Turn knob outside (anti-clockwise).

Notice: For full engagement of gear it is important to turn the knob completely outside (anti-clockwise).

## FITTING LIMIT SWITCHES (TO GATE)

- The drive should be disengaged before this part of the assembly work is carried out.
- Slide the gate into the closed position.
- Mount the limit switch bracket such that the roller of the first switch is situated approximately in the middle of the bracket. Repeat this process for the open position. The bracket must be mounted with screws immediately.

## INITIAL OPERATION

Check gate functionality manually when the drive has been disengaged. Electrical operation is possible only if a controller (CB400) is connected.

## ELECTRICAL CONNECTION:

See electrical wiring diagram with control board CB400

- Control board pre-installed
- Limit switch pre-wired to NC contacts
- Motor pre-wired to control board box
- Control board box pre-installed

Always ensure that the mechanical and electrical safety requirements relevant to the given system are complied with. A sliding gate can also be secured by implementing on-site measures (fence, wall, etc.).

## MAINTENANCE WORK (monthly)

The drive mechanics are generally maintenance-free. Check at regular intervals that the gate hardware and the drive are all firmly in place.

- Disengage the drive and check gate functionality. Only an easy-running gate will work well with a drive. A drive is no substitute for a poorly functioning gate.
- Inspect for oil leakage on gear box.
- Inspect for damage to electrical wiring



**Declaration of Conformity**

Automatic Gate Opener Models..... SLY2500  
are in conformity to the applicable sections of Standards:

EN55014 • EN61000-3 • EN60555, EN60335-1 • ETS300 683 • EN60335-1: 2002 • EN60335-2-103:  
2003 • EN55014-1: 2000 + A1 + A2 • EN55014-2: 2001 • EN61000-3-2: 2000 • EN61000-3-3: 1995 +  
A1 • EN 301 489-3, V1.3.1 • EN13241-1

per the provisions & all amendments  
of the EU Directives .....2006/95/EC, 2004/108/EC, 1999/5/EG

**Declaration of Incorporation**

Automatic Gate Opener Models , when installed and maintained according to all the Manufacturer's  
instructions in combination with a Gate, which has also been installed and maintained according to all  
the Manufacturer's instructions, meets the provisions of EU Directive 89/392/EEC and all  
amendments.

*I, the undersigned, hereby declare that the equipment  
specified above and any accessory listed in the manual  
conforms to the above Directives and Standards.*

Harry Naumann  
Manager, Regulatory Affairs  
Chamberlain GmbH  
D-66793 Saarwellingen  
Germany  
October, 2008



A handwritten signature in black ink, appearing to read 'Harry Naumann', written over a horizontal line.

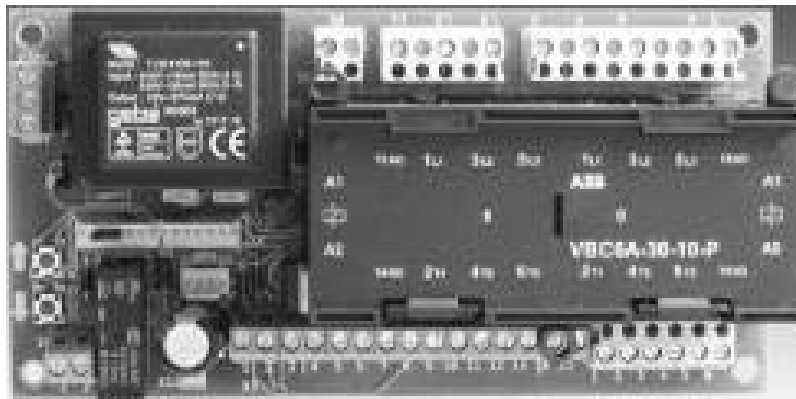

CONTROL BOARD KIT  
CB400  
for  
AC SLIDING GATE OPERATORS  
-Installation Instructions-

[www.liftmaster.de](http://www.liftmaster.de)  
Email: [info@chamberlain.de](mailto:info@chamberlain.de)

- int** Int. Service (+49) 6838/907 172
- de** für Service 06838/907 172
- en** for service (+44) 0845 602 4285
- fr** pour service 03 87 95 39 28
- nl** voor service 020 684 7978

Chamberlain GmbH  
Alfred Nobel Strasse 4  
D-66793 Saarwellingen  
Germany

## WARNING / ATTENTION

### IMPORTANT FITTING AND OPERATING INSTRUCTIONS

PLEASE START BY READING THESE IMPORTANT SAFETY RULES • SAVE THESE INSTRUCTIONS



This safety alert symbol means "Caution" - failure to comply with such an instruction involves risk of personal injury or damage to property. Please read these warnings carefully.

This gate drive mechanism is designed and tested to offer appropriately safe service provided it is installed and operated in strict accordance with the following safety rules.



*Incorrect installation and/or failure to comply with the following instructions may result in serious personal injury or property damage.*



*When using tools and small parts to install or carry out repair work on a gate exercise caution and do not wear rings, watches or loose clothing.*



Installation and wiring must be in compliance with your local building and electrical installation codes. Power cables must only be connected to a properly earthed supply.



*Any entrapment possibility by the moving wing between wing & walls must be secured with safety edges or IR-sensors.*



Please remove any locks fitted to the gate in order to prevent damage to the gate.



After the installation a final test of the full function of the system and the full function of the safety devices must be done.



This drive cannot be used with a gate incorporating a wicket door unless the drive cannot be operated with the wicket door open.



Frequently examine the installation for imbalance and signs of wear or damage to cables, hardware and mountings. Do not use if repair or adjustment is necessary. Gates which stick or jam must be repaired immediately. Employ a qualified technician to repair the gate, never attempt to repair it yourself.



*Keep additional accessories away from children. Do not allow children to play with pushbuttons or remote controls. A gate can cause serious injuries as it closes.*



*Disconnect electric power to the system before making repairs or removing covers.*

A disconnecting device must be provided in the permanently-wired installation to guarantee all-pole disconnection by means of a switch (at least 3mm contact gap) or by a separate fuse.



Make sure that people who install, maintain or operate the gate drive and/or the control board are qualified and follow these instructions.

Keep these instructions in a safe place so that you can refer to them quickly when you need to.



*The full protection against potential squeeze or entrapment must work direct when the drive arms are installed.*

### Attention:

This product may only be installed from professional installers. Only qualified and trained electricians may connect, programme and service the controls. Qualified and trained electricians meet the following requirements:

- have knowledge of the general and specific safety and accident prevention regulations,
- have knowledge of the relevant electrical regulations,
- are trained in the use and care of appropriate safety equipment,
- are capable of recognising the dangers associated with electricity.

### Scope of these instructions:

These instructions describe the installation and options for the product CB400 (control board AS210B): Some features require the optional ZM-SKS plug in logic board to work. This manual should only be used together with SLY2500 and SLY3500 operators!

For mechanical installation of the operator use the instruction included with the operator.

## FEATURES

Type of gate motor used	<b>SLY2500</b>	<b>SLY3500</b>
Motor Voltage	230Volt	400Volt
Controller (CB400 kit)	AS210B	AS210B
Max. Gate weight (kg)	2500kg	3500kg
Motor Protection Switch	no	yes
Thermal protection (internal)	yes	no
Hold to run function	yes	yes
Automatic function	yes	yes
IR-Sensor	yes	yes
Radio	external	external
Automatic close	yes*	yes*
Flashing Light	yes*	yes*
Safety edges	yes*	yes*
Emergency Stop	yes*	yes*
External Light switching function	yes*	yes*
Traffic light with Red-Light	yes*	yes*

\* requires ZM-SKS-B plug in card

## **IMPORTANT:**

**BEFORE** the installation of control board make sure it is checked if your control motor requires to be set for 400Volt, 3-Phase or 230Volt, 1-Phase (X4 terminal).

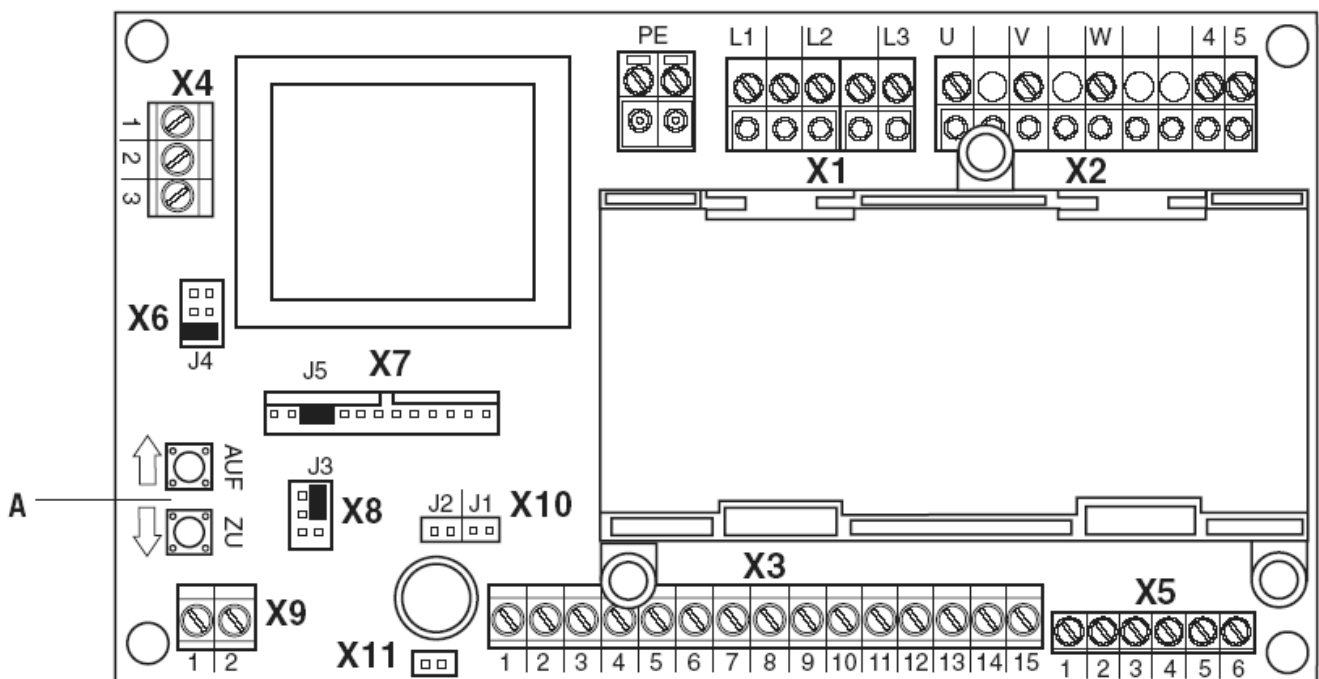

- A.** Test button OPEN direction (S01) /
- A.** Test button CLOSE direction (S02)

- X1:** Terminals Mains
- X2:** Terminals Motor / safety circuit of drive
- X3:** Terminals Command devices
- X4:** Terminals Selection 230V / 400V
- X5:** Terminals Limit switches

- X6:** Terminals for 3-way switch
- X7:** Plug-in socket for ZM-SKS-B circuit card
- X8:** Plug-in socket for spiral cable
- X9:** Terminals for traffic light / yard light  
(only in connection with a ZM SKS B plug-in circuit card)
- X10:** Terminals for press-and-release  
CLOSE- OPEN
- X11:** Not used



## Installation of control board:

The assembly instructions assume that there is no control board pre-installed.

### General steps:

1. Remove cover of operator
2. Remove control board box cover

### 3. Compare general pre-assembly of control board

- Picture 1: 230Volt 1-Phase motor assembly
- Picture 2: 400Volt 3-Phase motor with motor protection switch installed



Pic. 1

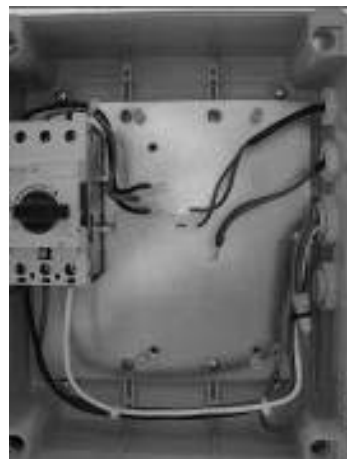

Pic. 2

### 4. Install the control board holders

- 4 pieces into the marked holes
- See picture 3



Pic. 3

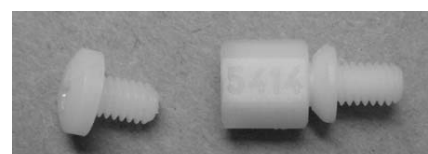

## Circuit diagram for mains connection and motor 400 V / 3-phase

- F1 Thermal fuse, control voltage  
 F2 Thermal overload protection for motor  
 K1 Protection OPEN  
 K2 Protection CLOSE  
 M Motor (400 V / 50 Hz / 3-phase)  
 S3 Safety limit switch OPEN (NC contact)  
 S4 Safety limit switch CLOSE (NC contact)  
 S7 Safety switch, emergency manual operation (NC contact)  
 T1 Transformer  
 X1 Terminal block for mains connection  
 X2 Terminal block for motor  
 X4 Terminal block for mains voltage selection  
 1+2 = 230Volt  
 2+3 = 400Volt

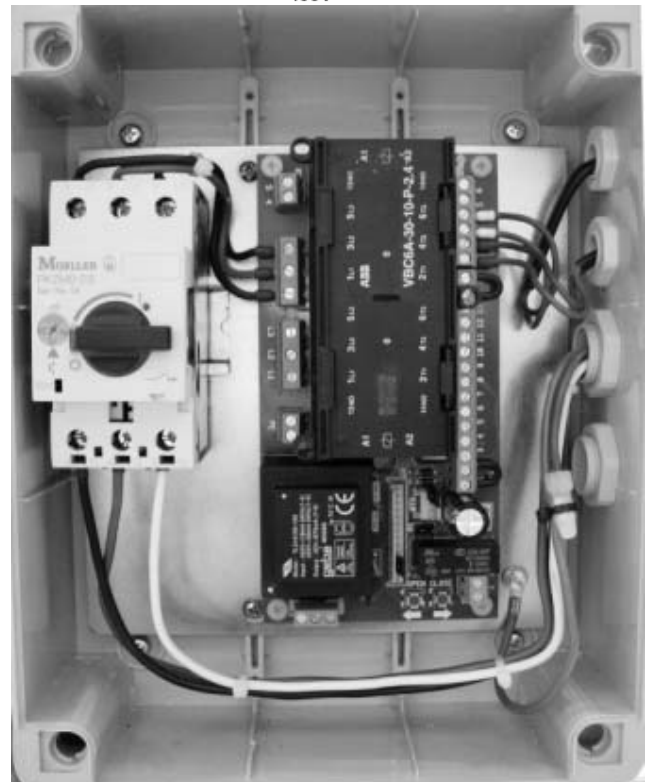
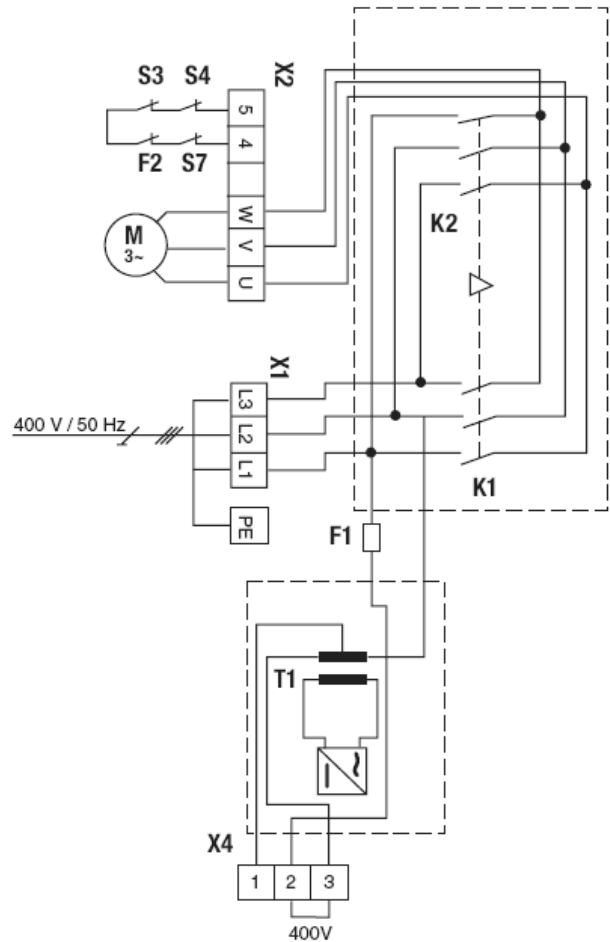

### Picture of general wiring 400Volt shows:

- Connection to motor via motor protection switch
- Limit switch connected (right side)
- Ground wire connected to board

### Not shown:

Connect mains to:

- L1 = L
- L2 = L
- L3 = L
- PE = PE

### **ATTENTION:**

**Terminal X4 must have a jumper between terminals 2+3 installed! (Picture 1)**



Pic. 1

## Circuit diagram for mains connection and motor 230V / 1-phase

- F1 Thermal fuse, control voltage  
 F2 Thermal overload protection for motor  
 K1 Protection OPEN  
 K2 Protection CLOSEM Motor (230 V / 50 Hz)  
 S3 Safety limit switch OPEN (normally closed contact)  
 S4 Safety limit switch CLOSE (normally closed contact)  
 S7 Safety switch, emergency manual operation (normally closed contact)  
 T1 Transformer  
 X1 Terminal block for mains connection  
 X2 Terminal block for motor  
 X4 Terminal block for mains voltage selection

Picture of general wiring 1-Phase 230Volt motor

- Connection to motor via motor protection switch
- Limit switch connected (right side)
- Ground wire connected to board

Not shown:

Connect mains to:

L2 = L- 230Volt

L1 = N Neutral

PE = PE

### ATTENTION:

**Terminal X4 must have a jumper between terminals 1 + 2 installed!  
(Picture 1)**

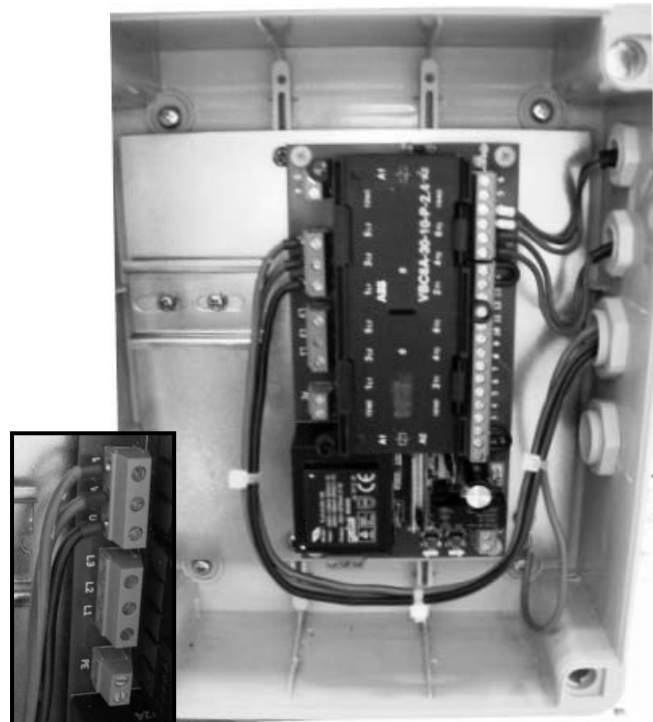
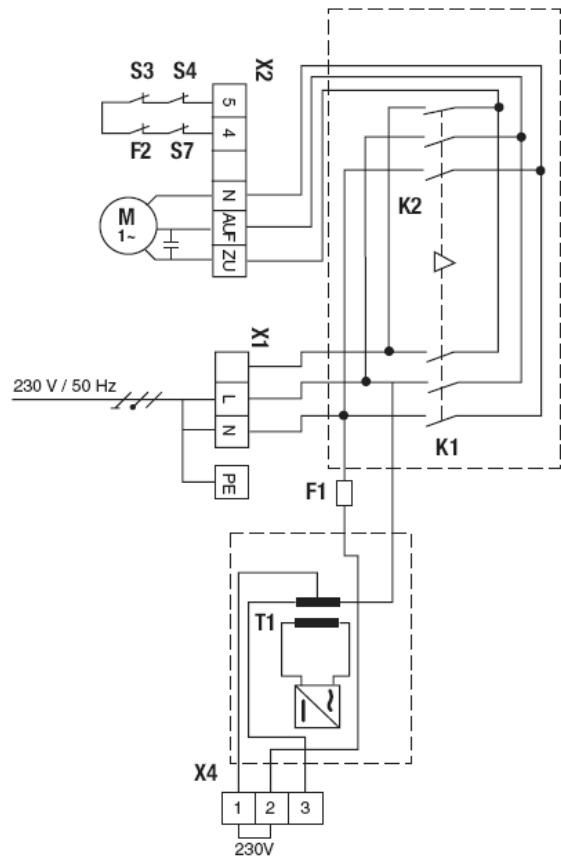

Pic. 1



## GENERAL CONNECTIONS:

### Terminals X5 and X2 Limit switches

1. Limit switch OPEN
2. Limit switch CLOSE
3. xx??
4. Pre-limit switch CLOSE (after activation the door does not reverse)
5. Thermal overload protection for motor
6. Emergency operation (normally closed contact)
7. Safety limit switch CLOSE
8. Safety limit switch OPEN

### Terminal block X3 Safety Devices and Commands

- 14 + 15 STOP Input  
 12 + 13 OPEN Direction Input  
 10 + 11 CLOSE Direction Input  
 7, 8 + 9 Safety Edges Closed Direction.  
 Requires the ZM-SKS module
- 5 + 6 Output 24Volt DC , max . 150mA  
 5 = +  
 6 = --
- 3 + 4 Radio input (Automatic operation)  
 Requires the ZM-SKS module
- 1 + 2 Photocell Close connection  
 Requires the ZM-SKS module

#### EXAMPLE:

OPEN/ STOP CLOSE (4 lead solution)

#### EXAMPLE:

OPEN / CLOSE

### Terminal block X9

- 1 + 2 Dry Contact for red light traffic light  
 or other lights

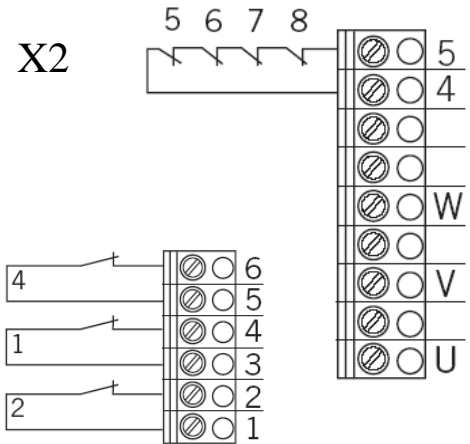

X5

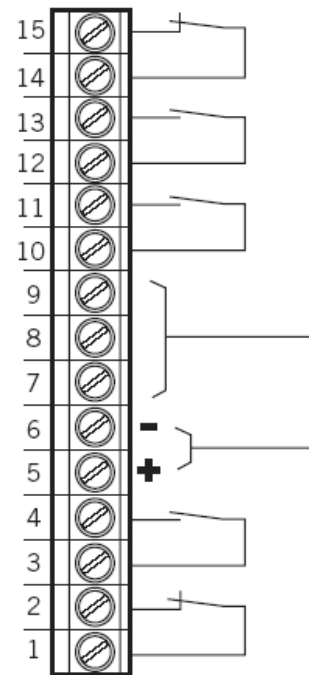

X3

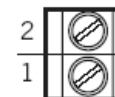
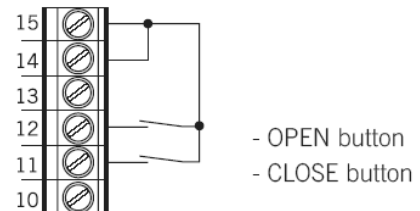
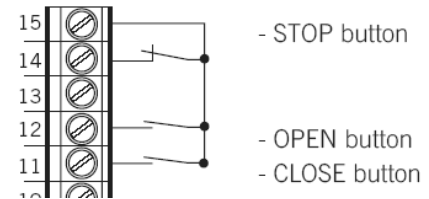

X9

## EXTERNAL SAFETY- DEVICES

### Connection (wiring) examples:

Requires optional ZM-SKS-B module to be installed

#### 1. For optoelectric safety edges:

##### Closing direction

Settings: Dipswitch 1 = OFF  
 Terminal 9: +12Volt  
 Terminal 8: Signal  
 Terminal 7: Ground

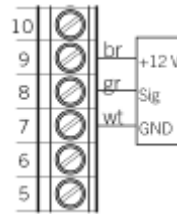

#### 2. For 8.2KOhm safety edges

##### Closing direction

Settings: Dipswitch 1 = ON  
 Terminal 7 + 8

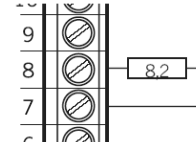

#### 3. For pneumatic safety edges

##### Closing direction

Settings: Dipswitch 1 = ON  
 Dipswitch 2 = ON  
 8.2KOhm resistor in place  
 Terminal 7+8

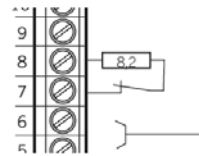

#### 4. For relay photocell with 3-wire technology

##### Closing direction

Terminal 5: +24Volt  
 Terminal 6: Ground  
 Terminal 2: Signal

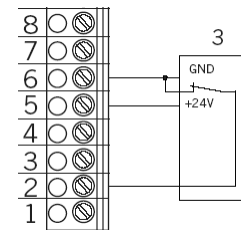

**Notice:** A 4-wire photocell requires a jumper to be added

#### 5. For relay photocell with 4-wire technology

##### OPENING direction

Terminal 14+15: Signal  
 Terminal 5 : + 24VDC  
 Terminal 6 : - 24VDC

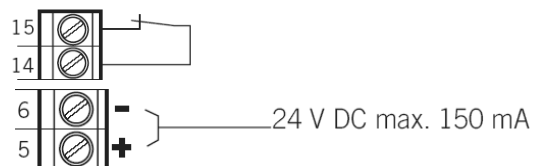

### MORE OPTIONS:

- For Chamberlain 2-wire photocells the optional 600213-2 interface box is required. Three more photocells or safety edges may be connected and monitored independently, Type suitable 8.2KOhm type or mixed with 2-wire Chamberlain photocells. The interface box can be connected to any terminal and connected to the safety output protecting the opening OR the closing direction. The box is IP55 and can be located outside.

## OTHER SETTINGS

### X6 Socket

#### Socket for an external 3-way switch.

If the terminal is not used by a connector plug the stop jumper marked on J4 must be inserted.

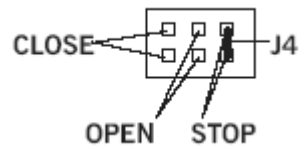

### X8 Socket

#### Socket for coiled (spiral) cable.

If the terminal is not used by a connector plug the jumper marked on J3 must be inserted.

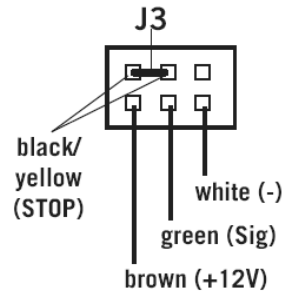

### X7 Socket

#### Socket for the ZM-SKS plug in board.

If the terminal is not used by the module the jumper marked J5 must be inserted.



### X10 Socket

#### Terminal for press and release full open and full close.

Opening direction: J1

Closing direction: J2

- J1 and J2 jumper OPEN if ZM-SKS board is used.
- J1 and J2 jumper CLOSED if not connected.

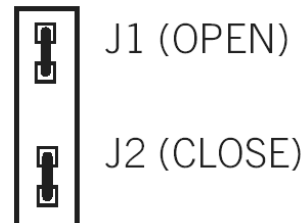

#### WARNING:

If jumper J2 is inserted the safety edge output does NOT reverse and stop the closing direction!

### X11 Socket

No Function

Dimensions of circuit board:	167 x 85 x 190	Relay outputs:*	if inductive loads are connected (e.g. additional relays or brakes), they must be fitted with appropriate interference suppression devices (free-wheeling diodes, varistors, resistor-capacitor elements). Potential-free normally open contact; min. 10 mA ; max. 230V AC / 4A. Contacts used once for power switching can not be subsequently used for connecting small currents.
Power supply via L1, L2, L3, PE:	230 V or 400 V, 50 / 60 Hz; - max. power input 2200 W - 3.2 A; duty cycle 60% for a maximum running time of 120 s		
Fuse protection:	10A K type		
Consumption of the controls alone:	max. 100 mA		
Control voltage:	24 V DC, max. 250 mA; protected by self-resetting fuse for external sensor systems; all control voltage inputs are galvanically isolated from the supply	Temperature range:	In operation: -10°C ... +45°C In storage: -25°C ... +70°C
Control inputs:	24V DC, all input connections must be potential-free; minimum signal duration for input control command >100 ms	Air humidity:	up to 80% not condensing
Control outputs:	24 V DC, max. 150 mA	Weight:	approx. 1.8 kg
Safety circuit / emergency off:	all input connections must be potential-free; if the safety circuit is interrupted, no further electrically powered movement of the drive is possible, not even in dead-man mode.	Guidelines:	Standards
Input -safety contact edge:*	for 8.2 kW electrical safety contact edges, terminating resistor and for dynamic optical systems		

**Declaration of Conformity**

Gate Control Board for SLY2500 and 3500..... AS210B is in conformity to the applicable sections of Standards:

EN55014 • EN61000-3 • EN60555, EN60335-1 • ETS300 683 • EN60335-1: 2002 • EN60335-2-103: 2003 • EN55014-1: 2000 + A1 + A2 • EN55014-2: 2001 • EN61000-3-2: 2000 • EN61000-3-3: 1995 + A1 • EN 301 489-3, V1.3.1 • EN13241-1

per the provisions & all amendments of the EU Directives .....2006/95/EC, 2004/108/EC, 1999/5/EG

**Declaration of Incorporation**

Automatic Gate Opener Models , when installed and maintained according to all the Manufacturer's instructions in combination with a Gate, which has also been installed and maintained according to all the Manufacturer's instructions, meets the provisions of EU Directive 89/392/EEC and all amendments.

*I, the undersigned, hereby declare that the equipment specified above and any accessory listed in the manual conforms to the above Directives and Standards.*

Harry Naumann  
Manager, Regulatory Affairs  
Chamberlain GmbH  
D-66793 Saarwellingen  
Germany  
July, 2008

