

Bedieningen



Bedieningspaneel



Afstandsbediening
(Art. Code: F60AC-TX)

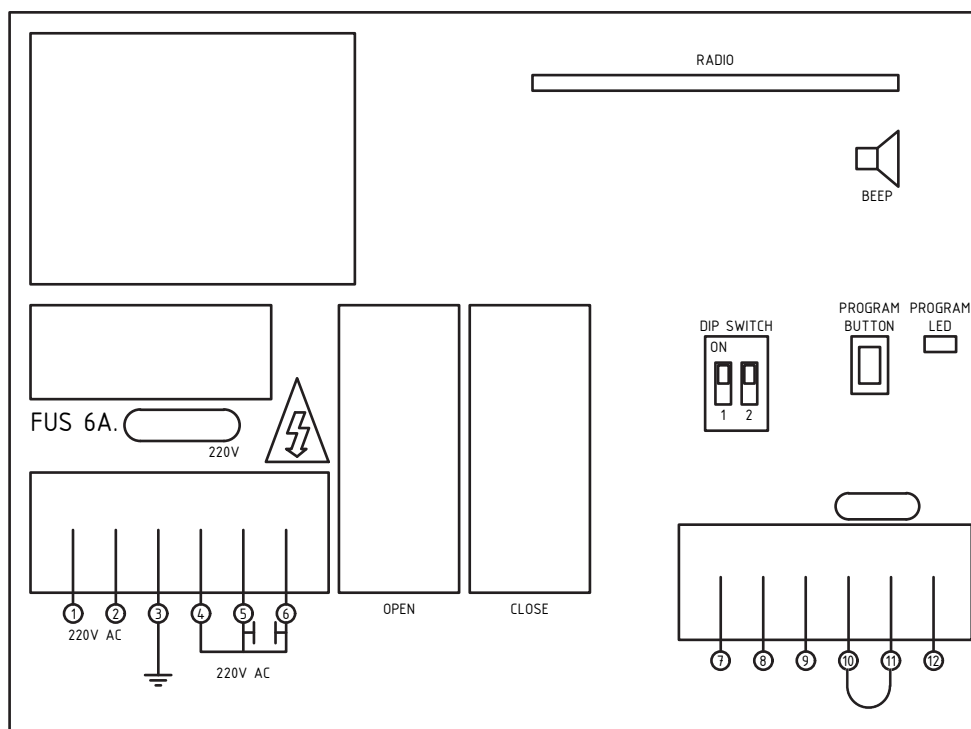

Opties

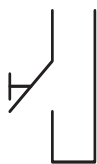

Drukknop



Schakelaar

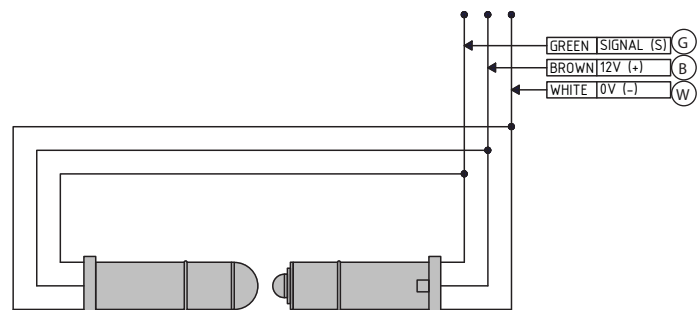

OPTICAL SENSOR (OPTO)

Let op: bij een defecte opto-sensor deur sluiten m.b.v. de ont koppeling, of leg een brugje tussen 8 en 9, zet dipswitch 1 op on en 2 op off. Sluit de deur in dodemans.

Let op: Gebruik van een DW contact of een reflexfotocel, (verbreekcontact aansluiten op 8-9 dipswitch 1 op on en 2 op off) werkt wel maar is niet zelftestend. Volgens de CE veiligheidsregels moet dit echter wel.

Installatie:

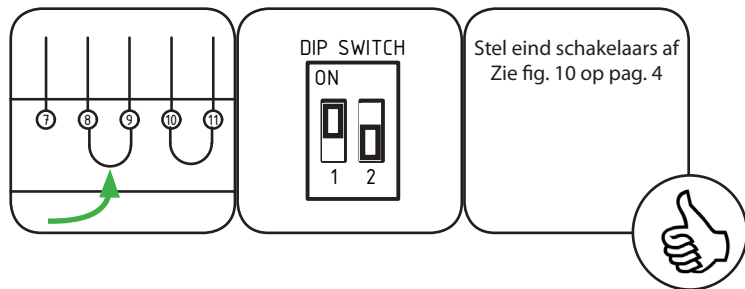

Optie 1: impuls open, dodemans dicht, geen beveiliging

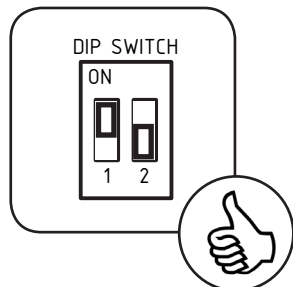

Optie 2: opto-sensor, impuls open, impuls dicht

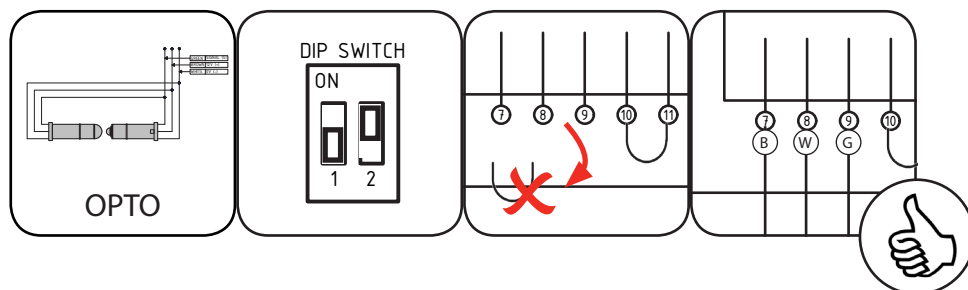

Optie 3: afstandsbediening programmeren

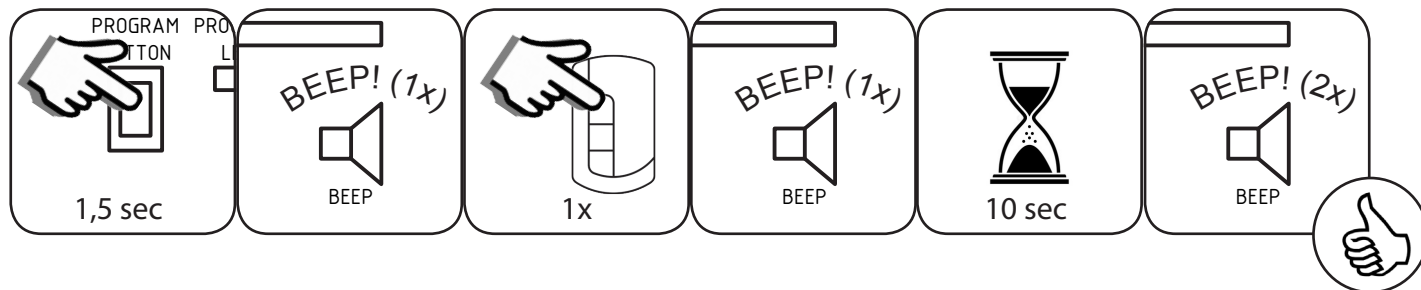

Optie 4: extra drukknop

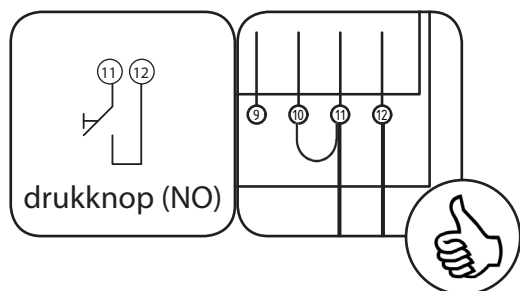

Optie 5: onderloopbeveiliging

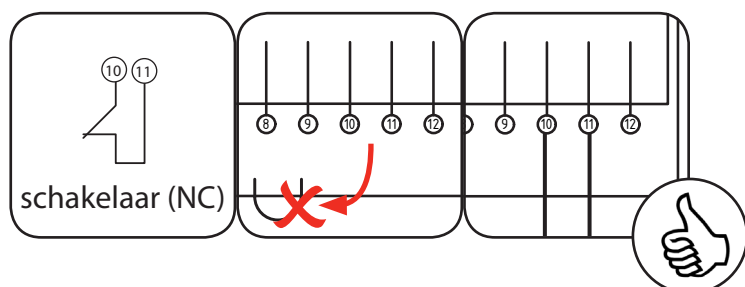

Optie 6: looptijd programmeren

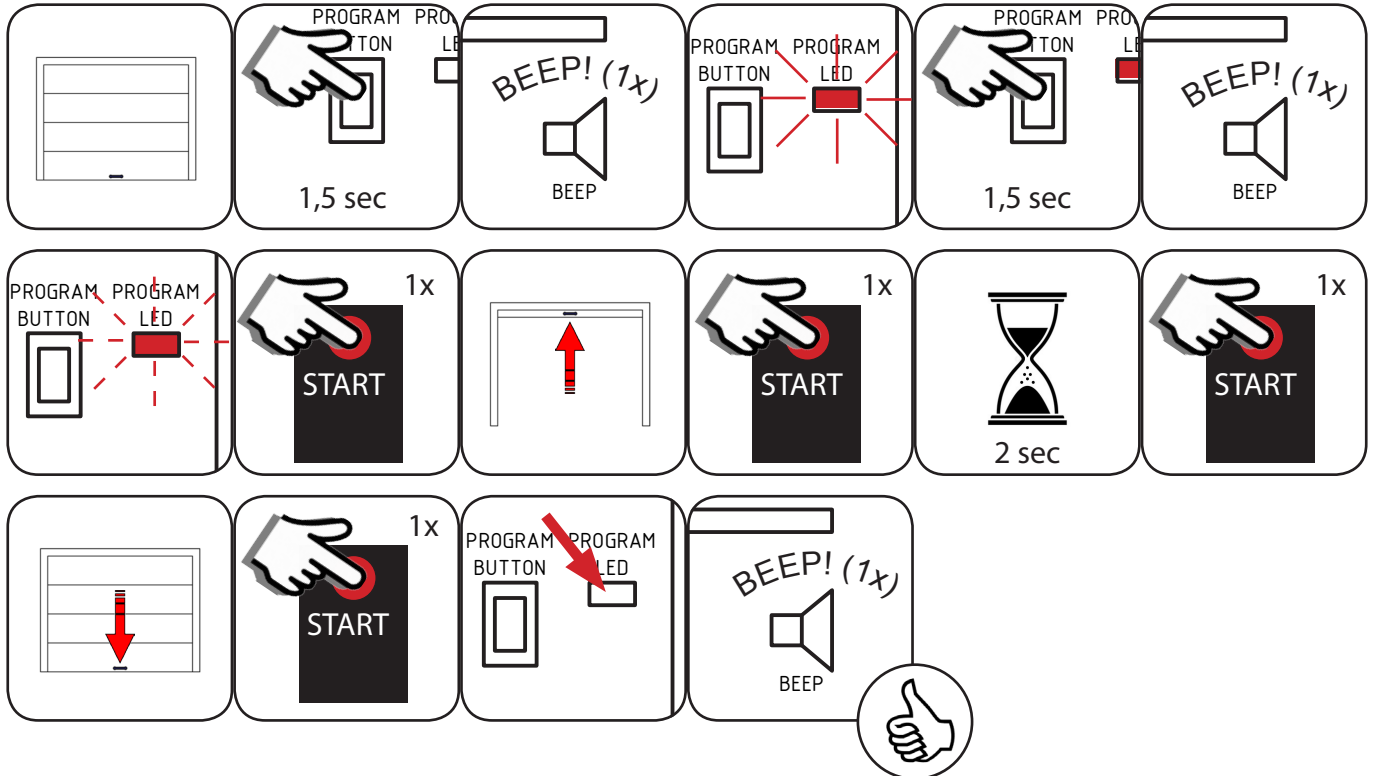

Optie 7: Automatisch sluiten (alleen mogelijk met onderloopbeveiliging)

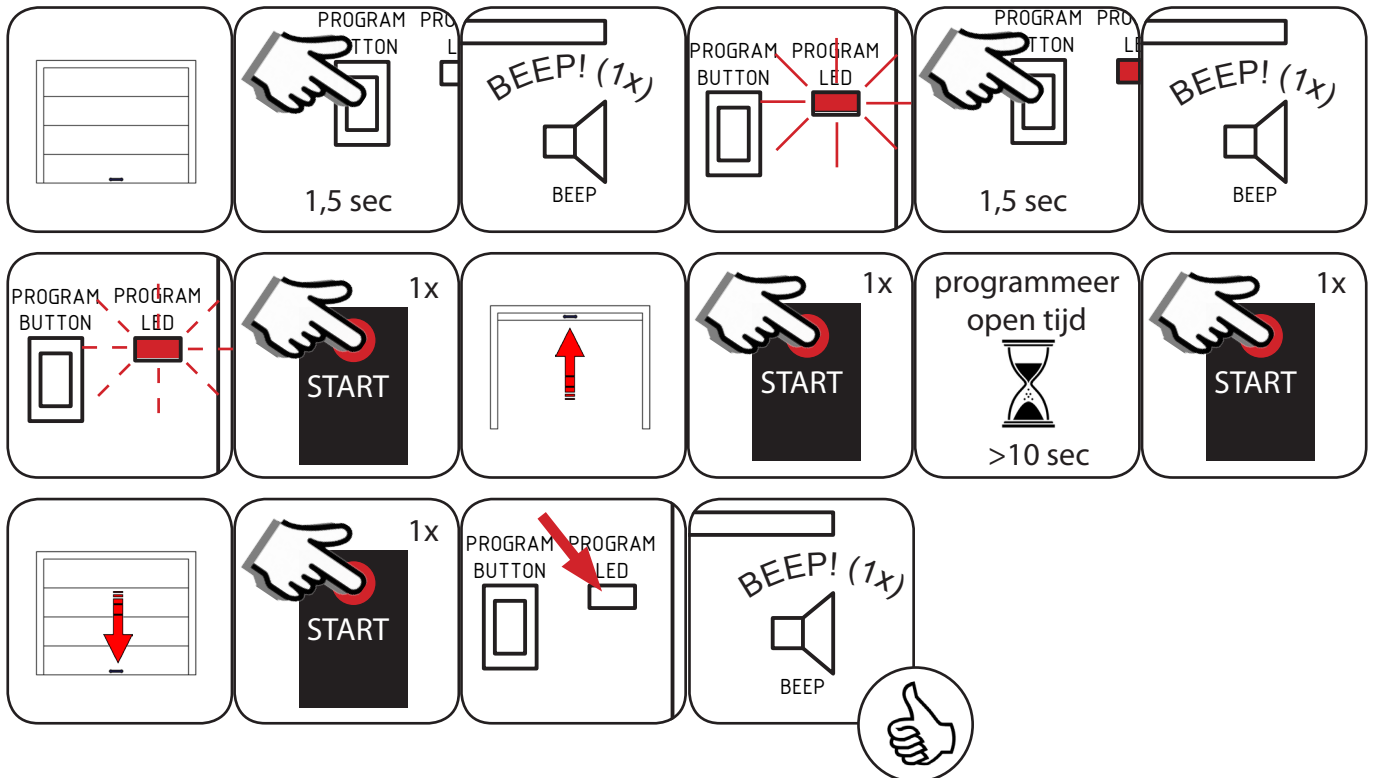

Fabrieksinstellingen terugzetten

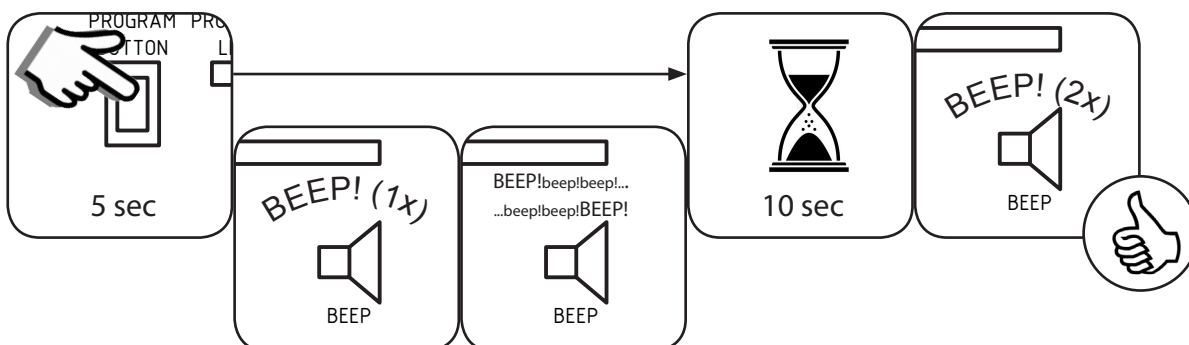
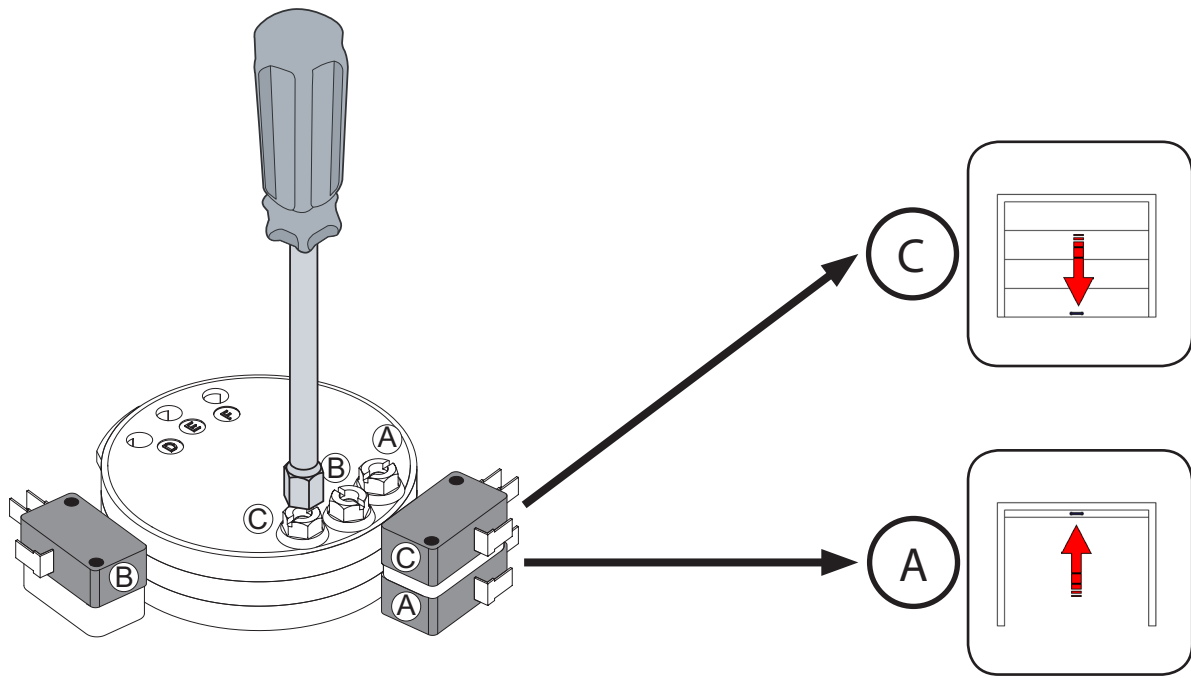

fig.: 10



Main features

Travel control system	Mechanical rotary limit switch
Control type	Automated
Duty class	4-heavy
Duty cycles	S2=30 min / S3=50%
Power supply	230V~/50Hz
Insulation class	class 1
Input	3A
Torque	60Nm
Drive shaft RPM	22 RPM
Release system	By cable
Operating temperature	-20°C / +55°C / (-35°C / +55°C with NIO enabled)
Protection class	IP 54